

GS 04L45B02-01EN

OVERVIEW

The DX2000T is a Daqstation that displays real-time measured data on a color LCD and saves data on a CompactFlash memory card (CF card). It can be hooked up to network via Ethernet, which enables to inform by E-mail and to monitor on Web site as well as to transfer files by using FTP. Also, it can communicate with Modbus/RTU or Modbus/TCP.

It comes with a four, eight, ten, twenty, thirty, forty-channel or forty eight-channel model. As the input signal, a DC voltage, thermocouple, resistance temperature detector, or contact signal can be set to each channel. The data saved on a CF card can be converted by data conversion software to Lotus 1-2-3, Excel, or ASCII format file, facilitating processing on a PC. Not only this, the Viewer software allows a PC to display waveforms on its screen and to print out waveforms.



STANDARD SPECIFICATIONS

General Specifications

Construction

Mounting: Flush panel mounting (on a vertical plane)
Mounting may be inclined downward up to 30 degrees from a horizontal plane.

Allowable panel thickness:
2 to 26 mm

Material: Case: drawn steel
Bezel: polycarbonate
Display filter: polycarbonate

Case color:
Case: Grayish blue green (Munsell 2.0B 5.0/1.7 or equivalent)
Bezel: Charcoal grey light (Munsell 10B 3.6/0.3 or equivalent)

Front panel:
Water and dust-proof*
(based on IEC529-IP32 for indoor locations (except external icing test))
*Except for side-by-side mounting.

Dimensions:
288 (W) × 288 (H) × 221.6 (D) mm
288 (W) × 288 (H) × 226 (D) *mm
*In case of /H2 or /PM1 option is specified.

Weight:
DX2004T, DX2010T: approx. 6.0 kg*
DX2008T, DX2020T: approx. 6.3 kg*
DX2030T : approx. 6.9 kg*
DX2040T, DX2048T: approx. 7.3 kg*
*without optional features

Input

Number of inputs:
DX2004T: four channels
DX2008T: eight channels
DX2010T: ten channels
DX2020T: twenty channels
DX2030T: thirty channels
DX2040T: forty channels
DX2048T: forty eight channels

Measurement interval:
DX2004T, DX2008T:
125 ms, 250 ms, 25 ms (fast sampling mode*)
DX2010T, DX2020T, DX2030T, DX2040T, DX2048T:
1 s (Not available when A/D integration time is set to 100 ms), 2 s, 5 s, 125 ms (fast sampling mode*)
* A/D integration time is fixed to 1.67 ms in case of fast sampling mode.

Inputs: DCV (DC voltage), TC (thermocouple), RTD (resistance temperature detector), DI (digital input for event recording), DCA (DC current with external shunt resistor attached)

Input type	Range	Measuring range	
DCV	20 mV	-20.000 to 20.000 mV	
	60 mV	-60.00 to 60.00 mV	
	200 mV	-200.00 to 200.00 mV	
	2 V	-2.0000 to 2.0000 V	
	6 V	-6.000 to 6.000 V	
	1-5V	-0.800 to 5.200 V	
	20 V	-20.000 to 20.000 V	
	50 V	-50.00 to 50.00 V	
TC	R ¹	0.0 to 1760.0°C	32 to 3200°F
	S ¹	0.0 to 1760.0°C	32 to 3200°F
	B ¹	0.0 to 1820.0°C	32 to 3308°F
	K ¹	-200.0 to 1370.0°C	-328 to 2498°F
	E ¹	-200.0 to 800.0°C	-328.0 to 1472.0°F
	J ¹	-200.0 to 1100.0°C	-328.0 to 2012.0°F
	T ¹	-200.0 to 400.0°C	-328.0 to 752.0°F
	N ¹	-270.0 to 1300.0°C	-454 to 2372°F
	W ²	0.0 to 2315.0°C	32 to 4199°F
	L ³	-200.0 to 900.0°C	-328.0 to 1652.0°F
	U ³	-200.0 to 400.0°C	-328.0 to 752.0°F
	WRe ⁴	0.0 to 2400.0°C	32 to 4352°F
RTD	Pt100 ⁵	-200.0 to 600.0°C	-328.0 to 1112.0°F
	JPt100 ⁵	-200.0 to 550.0°C	-328.0 to 1022.0°F
DI	DCV input (TTL)	OFF : less than 2.4 V ON : more than 2.4 V	
	Contact input	Contact ON/OFF	

*1 R, S, B, K, E, J, T, N: IEC584-1 (1995), DIN IEC584, JIS C 1602-1995
 *2 W: W-5% Re/W-26% Re (Hoskins Mfg. Co.), ASTM E988
 *3 L: Fe-CuNi, DIN43710, U: Cu-CuNi, DIN43710
 *4 WRe: W-3%Re/W-25%Re (Hoskins Mfg. Co.)
 *5 Pt100: JIS C 1604-1997, IEC 751-1995, DIN IEC751-1996
 JPt100: JIS C 1604-1989, JIS C 1606-1989
 Measuring current: i = 1mA

A/D integration time:

20 ms (50 Hz), 16.7 ms (60 Hz), 100ms (50/60Hz for DX2010T/DX2020T/DX2030T/DX2040T/DX2048T), or AUTO selectable (automatic selection by detection of power supply frequency)
 A/D integration time is fixed to 1.67 ms (600Hz) in case of fast sampling mode.

Thermocouple burnout:

Burnout upscale/downscale function can be switched on/off (for each channel).
 Burnout upscale/downscale selectable
 Normal: Less than 2 kΩ, Burn out: More than 100 kΩ
 Detection current: approx. 10 μA

1-5V range burnout:

Burnout upscale/downscale function can be switched on/off (for each channel).
 Burnout upscale/downscale selectable
 Upscale burnout: More than +10% of configured span
 Downscale burnout: Less than -5% of configured span

Moving average:

Moving average on/off selectable for each channel
 Moving average cycles 2 to 400 selectable

Calculation:

Differential computation:

Between any two channels
 Available for DCV, TC, RTD and DI ranges.

Linear scaling:

Available for DCV, TC, RTD and DI ranges.
 Scaling limits: -30000 to 30000
 Decimal point: user-selectable
 Engineering unit: user-definable, up to 6 characters
 Over value: Exceeds ± 5% of scaling limits (on/off selectable)

Square root:

Available for DCV range.
 Scaling limits: -30000 to 30000
 Decimal point: user-selectable
 Engineering unit : user-definable, up to 6 characters
 Low level cut off: 0.0 to 5.0% of display span
 Over value: Exceeds ± 5% of scaling limits (on/off selectable)

1-5VDC scaling:

Available for 1-5VDC range.
 Scaling limits: -30000 to 30000
 Display span limit: 0.800 to 5.200
 Decimal point: user-selectable
 Engineering unit : user-definable, up to 6 characters
 Low level cut off: Fixed to lower span limit
 Over value: Exceeds ± 5% of scaling limits (on/off selectable)

Display

Display unit:

10.4-inch TFT color LCD (VGA, 640 x 480 pixels)

Note) In the part of crystal display, there are some pixels that can't always turn on or off. Please understand that the brightness of screen looks uneven because of characteristics of crystal display, but it is not out of order.

Touch panel specifications:

Type: Analog resistive touch panel
 Operating life: Minimum of 100,000 times
 Operating load: 0.1 to 2.0 N

(Note) To avoid scratching or damaging the surface, do not push or rub the touch panel's surface with a sharp object such as a knife.
 The following operations can be performed on the monitor display panel.
 - Touch operations in the Operator display menu and FUNC key menu
 - Display operations such as selecting items or scrolling through data with touch operation
 - Touch operations using the shortcut menu (Operator menu)

Display	Operations That Can Be Performed
Trend	Display operation: None Operator menu: Input message, input free message, acknowledge alarm, switch to Trend history, switch to the Home display
Trend History	Display operation: Move cursor, move waveform, operate calendar (e.g. select date) Operator menu: Operate search, switch display modes, switch to Alarm summary, switch to Message summary, switch to Trend history information, switch to Operation log (*1), exit Trend history, input message to add, input free message to add, perform sign operation (*1), acknowledge alarm
Overview	Display operation: Select channel Operator menu: Acknowledge alarm, acknowledge individual alarm (*1), reset alarm display, switch to Alarm summary, switch to Trend, switch to the Home display
Alarm Summary Message Summary	Display operation: Select item, switch between sort order and sort item, scroll through items Operator menu: Switch between time and user name (only in Memory summary), switch to Trend history, switch to Alarm summary, switch message displays, switch to Trend history information, switch to Operation log (*1), exit Trend history, acknowledge alarm, switch to the Home display
Memory Summary	Display operation: Select item, scroll through items, switch data types, display "Add information" dialog box Operator menu: Switch to Trend history, save selected data, save all data, save manual sample, save report data, switch between time and file name, switch save modes, exit save mode, reject media
History Information	Display operation: Switch pages Operator menu: Switch to Trend history, switch to Alarm summary, switch message displays, switch to Trend history information, switch to Operation log (*1)
Operation Log (*1)	Display operation: Scroll through items, display "Add information" dialog box Operator menu: Change display content, switch to Trend history, switch to Alarm summary, switch to Message summary, switch to Trend history information, switch to Operation log, exit Trend history, acknowledge alarm
Other Logs	Display operation: Scroll through items Operator menu: Acknowledge alarm, switch to the Home display
4 Displays	Display operation: Select 4 display positions Operator menu: Acknowledge alarm, switch to the Home display
Batch Overview (*2)	Display operation: Select batch Operator menu: Acknowledge alarm, switch to the Home display
Custom Display	Display operation: Input value, perform button/switch operation (execution mode) Operator menu: Input message, input free message, acknowledge alarm, switch to Trend history, switch to the Home display
Network Information Text Field	Display operation: Switch pages Operator menu: Acknowledge alarm, switch to the Home display
Other Displays	Display operation: None Operator menu: Acknowledge alarm, switch to the Home display

*1: Only available when the /AS1 option is selected
*2: Only available when the /BT2 option is selected

Touch panel operation lock:

Touch panel operation can be locked and unlocked with a password.

Touch panel correction:

The touch position can be corrected.

Display group:

Each measurement channel and computation channel can be assigned to display group of the trend, digital and bargraph display.

Number of display: 36 groups
Number of assignable channels for one group: 10 channels

Display color:

Trend/Bargraph:
Selectable from 24 colors

Background:

White or black selectable

Trend display:

Trend display type:

Vertical, horizontal, landscape, horizontal split or circular selectable

Number of indication channels:

10 channels per display (maximum)

Number of display:

36 displays (36 groups)

Line width:

1, 2, and 3 pixels selectable

Scales:

Maximum 10 scales.
Bargraph, green band area and alarm mark can be displayed on scale display.
Number of divisions: Selectable from 4 to 12 or C10 (10 divisions by main scale mark and scale values are displayed on 0, 30, 50, 70 and 100% position).

Trend update rate:

5, 10, 15, 30 sec., 1, 2, 5, 10, 15, 20, 30 min., 1, 2, 4, 10 hours/div selectable (5, 10 sec/div is available for only DX2004T and DX2008T. DX2010T, DX2020T, DX2030T, DX2040T, and DX2048T can be specified to 15 sec/div when they are in fast sampling mode.)

Circular waveform span rate:

20, 30 min., 1, 2, 6, 8, 12, 16 hours, 1, 2 days, 1, 2, 4 weeks/rev selectable (20 min/rev is available for only DX2004T and DX2008T)

Bargraph display:

Direction: Vertical or horizontal selectable

Number of indication channels:

10 channels per display

Number of display:

36 displays (36 groups)

Scales:

Green band area and alarm mark can be displayed on scale display.
Number of divisions: Selectable from 4 to 12
Reference position: Left, right or center

Display renewal rate: 1 s

Digital indication:

Number of indication channels:

10 channels per display

Number of display:

36 displays (36 groups)

Display renewal rate: 1 s

Overview display:

Number of indication channels:

Measuring values and alarm status of all channels

Information display:

Alarm summary display:

Display the list of latest 1000 alarms summary.
Jump to historical trend display by cursor pointing.

Message summary display:

Display the list of latest 450 messages and time.
Jump to historical trend display by cursor pointing.

Memory information:

Display the file list in internal memory.
Jump to historical trend display by cursor pointing.

<p>Report information: Display the report data in internal memory.</p> <p>Modbus status: Display the Modbus status.</p> <p>Relay status: Display the on/off status of internal switch and relay output.</p> <p>Stacked bar graph display: Display the periodic sums of report data.</p> <p>Event switch status: Display the event switch status.</p> <p>Log display: Log display types: Login log*1, error log, communication log, FTP log, Web log, E-mail log, SNTP log, DHCP log, Modbus log, operation log*2, setting change log*2 *1 operation log when the /AS1 option is installed *2 only for /AS1 option</p> <p>Tags: Display the tag number and tag comment. Tag number: Number of characters: 16 characters maximum Tag comment: Number of characters: 32 characters maximum</p> <p>Messages: Number of characters: 32 characters maximum Number of messages: 100 messages (including 10 free messages) Message adding function: Message can be added on historical display.</p> <p>Other display contents: Status display area: Date & time (year/month/day, hour:minute:second), batch name (batch number + lot number), login user name, display name, internal memory status, status indication icon Trend display area: Grid lines (number of divisions selectable from 4 to 12), hour : minutes on grid, trip levels (line widths are selectable from 1, 2 and 3 pixels)</p> <p>Data referencing function: Display the retrieved data (display data or event data) from internal or external memory. Display format: Whole display or divided to 2 areas Time axis operation: Display magnification or reduction, scroll by key operation Data searching operation: Display the retrieved data from internal memory by specifying date and time.</p> <p>Display auto scroll function: Display group of monitor display (trend display, bargraph display and digital display) automatically changes in a preset interval (5, 10, 20, 30 s and 1 min).</p> <p>Sign record: Only for /AS1 option</p> <p>LCD saver function: The LCD backlight automatically dims or off</p>	<p>(selectable) if no key is touched for a certain preset time (can be set from 1, 2, 5, 10, 30, and 60 min).</p> <p>Display register function: Up to 8 display types can be registered with display name.</p> <p>Display auto return function: The display type automatically returns to registered display type if no key is touched for a certain preset time (can be set from 1, 2, 5, 10, 20, 30 and 60 min)</p> <p>Temperature unit: °C or °F selectable</p> <p>Custom display function: Display can be customized by lay outing display parts. Display data is saved in internal memory or external medium. Number of customized display: 28 displays maximum (3 in internal memory and 25 in external medium)</p> <p>Display part: - General parts (digital, bar, label, tag number, tag comment, system icon, Modbus input, etc) - Scale parts - Trend parts - List parts (alarm list, message list) - Figure parts (line, rectangle, circle)</p> <p>Edit function: Select parts, grid, edit parts (move, resize, property, copy, paste, layout order change, dependency of visual property), group control, delete, save display</p> <p>Custom display data: Contents: Display contents data (for each display) Format: Text Output: External medium</p> <p>Custom display data save/load: Each or all custom display data file can be saved in specified directory. Custom display data can be loaded from specified directory.</p> <p>Data Saving Function External storage medium: Medium: CompactFlash memory card (CF card) Format: FAT16 or FAT32 Internal memory: Medium: Flash memory Capacity: 400MB Maximum number of files can be saved: 400 files (total number of display data file and event data file)</p> <p>Manual saving: Data files in internal memory can be saved manually. Selectable form all data saving or selected data saving. Drive: CF card or USB flash drive (only for USB option)</p> <p>Automatic saving: Display data: Periodic saving to CF card Event data: In case of trigger free...Periodic saving to CF card In case of using trigger...Save the data when sampling is finished</p>
---	--

Media FIFO function :
 Allows the oldest file to be deleted and the newest file to be saved if the free space on the CF card is insufficient (on/off selectable).

Sampling Period (data saving period):
 Display data file:
 Linked with the trend update rate
 Event file: Linked with the specified sampling period

Event File Sampling Period:
 DX2004T, DX2008T:
 Selectable from 25, 125, 250, 500 ms, and 1, 2, 5, 10, 30, 60, 120, 300, 600, 900, 1200 and 1800 s*

DX2010T, DX2020T, DX2030T, DX2040T, DX2048T:
 Selectable from 125, 250, 500 ms, and 1, 2, 5, 10, 30, 60, 120, 300, 600, 900, 1200 and 1800 s*

*Sampling period faster than measurement interval can not be selected.

Measurement data File:
 The following two file types can be created.
 Event file (stores instantaneous values sampled periodically at a specified sampling period)
 Display data file (stores the maximum and minimum values for each sampling period from among measured data sampled at measurement intervals)

Files can be created in the following combinations.
 (a) Event file + display data file
 (b) Display data file only
 (c) Event file only

Data format: YOKOGAWA private format (Binary)
 Maximum data size per file:
 8,000,000 byte (8MB)
 Data per channel:
 Display data file:
 Measurement data.....4 byte/data
 Mathematical data.....8 byte/data
 External channel data..4 byte/data

Event data file:
 Measurement data.....2 byte/data
 Mathematical data.....4 byte/data
 External channel data..2 byte/data

Sampling time:
 The sampling time per file (8MB) during manual data saving can be determined by the formula "number of data items per channel x interval of data saving (sampling period)."
 This logic is explained in more detail below:

- 1) When handling display data files only
 If we assume that the number of measuring channels is 30, the number of computing channels is 10, and the trend update rate is 30 min/div (60 sec sampling period), then:
 Number of data items per channel = 8,000,000 bytes/(8 bytes(time stamp) + 30 x 4 bytes + 10 x 8 bytes) = 38,462 data items
 Sampling time per file = 38,462 x 60 sec = 2,307,720 sec = approx. 26 days
- 2) When handling event files only
 If we assume that the number of measuring channels is 30, the number of computing channels is 10, and the sampling period is 1 sec, then :
 Number of data items per channel = 8,000,000 bytes/(8 bytes(time stamp) + 30 x 2 bytes + 10 x 4 bytes) = 74,074 data items
 Sampling time per file = 74,074 x 1 sec = 74,074 sec = approx. 20 hours
- 3) When handling both display data files and event files
 The sampling time is calculated by defining the size of data items in a display data file as 8,000,000 bytes and the size of data items in an event data file as 8,000,000 bytes. The method of calculation is the same as shown above.

Examples of Sampling Time for 1 file (8MB)*:
 *If sampling time exceeds 31 days, data file is divided.

In case measurement ch = 8 ch, mathematical ch = 0 ch

Display data file (approx.)

Trend update rate (time/div)	15 s	30 s	1 min	2 min	5 min	10 min
Sampling period	0.5 s	1 s	2 s	4 s	10 s	20 s
Sampling time	27.8 h	2 days	4 days	9 days	23 days	46 days

Event data file (approx.)

Sampling period	25 ms	125 ms	0.5 s	1 s	2 s	5 s	10 s
Sampling time	2.3 h	11.6 h	46.3 h	3 days	7 days	19 days	38 days

In case measurement ch = 48 ch, mathematical ch = 60 ch

Display data file (approx.)

Trend update rate (time/div)	15 s	1 min	5 min	10 min	20 min	30 min	1 h	2 h
Sampling period	0.5 s	2 s	10 s	20 s	40 s	1 min	2 min	4 min
Sampling time	1.6 h	6.5 h	32.7 h	2 days	5 days	8 days	16 days	32 days

Event data file (approx.)

Sampling period	25 ms	125 ms	0.5 s	1 s	10 s	30 s	1 min	2 min
Sampling time	NA	48 min	3.2 h	6.5 h	2 days	8 days	16 days	32 days

Manual sample data:
 The measuring and computing data can be saved manually to the internal memory and CF card.
Trigger: Key operation, communication command or event action function
Data format:
 Text
Max. number of data:
 400 data (if exceeds 400 data, oldest data is overwritten)
Report data (only for MATH option):
Types: Hourly, daily, hourly + daily, daily + weekly, and daily + monthly
Data format:
 Text
Drive: CF card
Trigger function:
 Selectable from FREE or TRIG for event data saving.
Trigger mode:
 Selectable from free, single or repeat trigger
Data length:
 Selectable from 10, 20, 30 min, 1, 2, 3, 4, 6, 8, 12 hour, 1, 2, 3, 5, 7, 10, 14, 31 day
Pre trigger: Selectable from 0, 5, 25, 50, 75, 95, 100%
Trigger source:
 Key operation, communication command or event action function
Display hard copy:
Trigger: Key operation, communication command or event action function
Data format:
 png format
Drive/output:
 CF card or communication interface
Data file retrieving function:
 Data file in CF card or USB flash drive (only for USB option) can be retrieved and displayed.
Retrieved data file:
 Display data file or event data file
Saving and retrieving of configuration data:
 Configuration information can be saved and retrieved as text data.
Drive: CF card or USB flash drive (only for USB option)

Alarm Function

Number of alarm levels:
 Up to four levels for each channel
Alarm types:
 High and low limits, differential high and low limits, high and low rate-of-change limits and delay high and low
Alarm delay time:
 1 to 3600 s*
 * with the /AS1 option, it can be setup to 24 hours
Interval time of rate-of-change alarms:
 The measurement interval times 1 to 32
Display: The alarm status (type) is displayed in the digital value display area upon occurrence of an alarm. A common alarm indication is also displayed.
 Alarm display color and display order can be changed by configured importance level and color.
Alarming behavior:
 non-hold or hold-type can be selectable for common to all channels.

Hysteresis: On/off selectable (common to measurement channels, mathematical channels or external channels)
 0.0 to 5.0% of display span (or scaling span)
Outputs:
Output: Internal switch or relay output (optional)
Number of internal switch:
 30 points
Internal switch action:
 AND/OR
Number of relay output points:
 2, 4, 6, 12, 22 or 24 points (optional)
Relay action:
 Energized/deenergized, hold/non-hold, AND/OR, alarm reflash selectable.
Alarm no logging function:
 When alarm occurs, only internal switch or relay output is activated. There are no alarm display on screen and no record on alarm summary.
 On/off selectable for each channel and alarm level.
Memory:
 The times of alarm occurrences/recoveries, alarm types, etc. are stored in the memory.
 Up to 1000 latest alarm events are stored.
Alarm annunciator function:
 Alarm display and relay output based on alarm sequence.
 Alarm sequence: 3 types (ISA-A-4, ISA-A, ISA-M)
 First out display function: Not available

Event action function

General: Particular action can be executed by particular event.
Number of event action:
 40 actions can be set
Event list:

Event	Level/Edge	Description
Remote	Level/Edge	Action by remote control signal
Relay	Level/Edge	Action by relay operation
Internal switch	Level/Edge	Action by internal switch operation
Alarm	Level/Edge	Action by any alarm
Timer	Edge	Action by timer time up
Match time	Edge	Action by time up of match time timer
USER key	Edge	Action by USER key operation
Event level switch	Level/Edge	Action by custom display, or communication command
Event edge switch	Edge	Action by custom display, FUNC display or communication command
Alarm OFF	Level/Edge	Action by alarm OFF
Internal switch OFF	Level/Edge	Action by internal switch OFF
Relay OFF	Level/Edge	Action by Relay OFF
Level switch OFF	Level/Edge	Action by level switch OFF

Action list:

Action	Level/Edge	Description
Memory start/stop	Level	Memory start and stop
Memory start	Edge	Memory start
Memory stop	Edge	Memory stop
Event trigger*	Edge	Event data sampling start
Alarm ACK	Edge	Alarm ACK
Math start/stop	Level	Computation start and stop
Math start	Edge	Computation start
Math stop	Edge	Computation stop
Math reset	Edge	Computation reset
Manual sample	Edge	Manual sample
Snapshot	Edge	Save display image to external media
Message input	Edge	Message writing
Trend update rate change	Level	Change trend update rate
Display data save	Edge	Save currently sampled display data to internal memory as a file
Event data save	Edge	Save currently sampled event data to internal memory as a file
Relative time timer reset	Edge	Reset relative time timer
Display group change	Edge	Change to specified display group
Time adjustment	Edge	Adjust internal clock to the nearest hour
Flag	Level	Normal: "0", Event: "1"
Setting file load*	Edge	Load setting file from CF card (up to 3 setting files).
Alarm display reset	Edge	Reset alarm display
Comment display	Edge	Display comment
Favorite display	Edge	Display registered favorite screen

* Not available with /AS1 option.

Security functions*

General: Login function or key lock function can be set for each key operation or communication operation.

Key lock function: On/off and password can be set for each operation key and FUNC operation. (Not available with /AS1 option)

Login function: Using the login function described below, you can enter security settings on the instrument

- User name
- Password

User level and number of users:

System administrator: 5 users (all can be operated)

General user: 30 users (With user restrictions, you can set restrictions on each operation key and FUNC display operation.)

User restrictions setting: 10 kinds (for general users)

* If the /AS1 option is installed, see the advanced security function (/AS1) specifications on page 15

Clock

Clock: With calendar function (year of grace)

Clock accuracy: ± 10 ppm, excluding a delay (of 1 second, maximum) caused each time the power is turned on.

Time setting method: Key operation, communication command,

event action function or SNTP client function

Time adjustment method: During memory sample: Adjust 40 ms per second (No influence for measurement period)

During memory stop: Adjust at a time

Time zone: Time difference from GMT: Settable from -1300 to 1300

Date display format: Selectable from YYYY/MM/DD, MM/DD/YYYY, DD/MM/YYYY or DD.MM.YYYY

DST function (summer/winter time): The time at which the daylight savings time adjustment is automatically calculated and configured.

Communication Functions

Electrical specifications: Confirms to IEEE802.3 (DIX specification for Ethernet frames)

Connection: Ethernet (10BASE-T)

Protocols: TCP, UDP, IP, ICMP, ARP, DHCP, HTTP, FTP, SMTP, SNTP, Modbus, DX private, EtherNet/IP

E-mail inform function: E-mail is sent by events as below.

- Alarm occurring/alarm canceling
- Recover from power failure
- Memory end
- Storage medium error, FTP client function error
- Specified time period
- Report data time up (only for mathematical option)
- When a user locked (only for /AS1 option)

POP before SMTP and SMTP authentication (PLAIN and CRAM-MD5) is available.

FTP client function: Data file auto-transfer from DX

Transferred data file: Display data file, event data file, report data file and display image file, setting file (only for /AS1 option)

FTP server function: File transfer from DX, file elimination (Not available with /AS1 option), directory operation and file list output are available by request from host computer.

Web server function: Display image of DX and alarm information can be displayed on web browser. Display the data searching display and report data of DX on web browser. You can have a buzzer sound on the PC when an alarm occurs on the DX.

SNTP client function: The time on DX can be synchronized to the time of a SNTP server.

SNTP server function: The DX can operate as a SNTP server.

DHCP client function: Network address configuration can be obtained automatically from DHCP server.

Obtained information: IP address, subnet mask, default gateway and DNS information

- Modbus client function:
 - Reading or writing of measurement data on other instruments are available by Modbus protocol.
 - Mathematical option or external input option is required to read the data from other instruments.
- Modbus server function:
 - Output of measurement data from DX is available by Modbus protocol.
 - Control operation such as message or batch name writing is available.
 - Access control from Modbus client to register is available by IP filtering function.
- Setting/measurement server function:
 - Operation, setting or output of measurement data are available by DX private protocol.
- Maintenance/test server function:
 - Output connection information or network information of the Ethernet communication.
- Instrument information server function:
 - Output instrument information such as serial number or model name of DX.
- EtherNet/IP server function:
 - Reading of measurement data or mathematical channel data
 - Reading or writing of external channel data
 - Reading or writing of communication input channel

Batch function

- General: Data display and data management with batch name, text field function and batch comment function are available.
- Batch name:
 - Batch name can be used as file name of display data, event data and report data.
 - Batch name format:
 - Batch number (max. 32 characters) + lot number (max. 8 characters)
 - Use/not use selectable for lot number, on/off selectable for auto increment function
- Text field function:
 - Field number: 1 to 24
 - Field title: Max. 20 characters
 - Field text: Max. 30 characters
- Batch comment function:
 - Batch comment is added to display data and event data.
 - Batch comment information:
 - 3 comments (max. 50 characters) are available.

Power Supply

- Rated power supply: 100 to 240 VAC (automatic switching)
- Allowable power supply voltage range: 90 to 132 or 180 to 264 VAC
- Rated power supply frequency: 50/60 Hz (automatic switching)
- Power consumption:

Supply voltage	LCD off	Normal	Max.
100 VAC	28 VA	42 VA	74 VA
240 VAC	38 VA	54 VA	100 VA

- Allowable interruption time:
 - Less than 1 cycle of power supply frequency

Other Specifications

- Memory backup :
 - A built-in lithium battery backs up the setup parameters (battery life : approximately 10 years at room temperature).
- Insulation resistance:
 - Each terminal to ground terminal: 20 MΩ or greater (at 500 VDC)
- Dielectric strength:
 - Power supply to ground terminal: 2300 VAC (50/60 Hz), 1 min
 - Contact output terminal to ground terminal: 1600 VAC (50/60 Hz), 1 min
 - Measuring input terminal to ground terminal: 1500 VAC (50/60 Hz), 1 min
 - Between measuring input terminals: 1000 VAC (50/60 Hz), 1 min (except for b-terminal of RTD input of DX2010T, DX2020T, DX2030T, DX2040T and DX2048T)
 - Between remote control terminal to ground terminal: 1000 VDC, 1 min

Safety and EMC Standards

- CSA: CSA22.2 No61010-1
Installation category II¹, pollution degree 2²
- UL: UL61010-1 (CSA NRTL/C)
- CE:
 - EMC directive:
 - EN61326-1 compliant, Class A Table 2
 - EN61000-3-2 compliant
 - EN61000-3-3 compliant
 - EN55011 compliant, Class A Group 1
 - Low voltage directive:
 - EN61010-1 compliant, measurement category II³, pollution degree 2²
- C-Tick: EN55011 compliant, Class A Group 1
 - *1: Installation Category (Overvoltage Category) II
Describes a number which defines a transient overvoltage condition. It implies the regulation for impulse withstand voltage. "II" applies to electrical equipment which is supplied from fixed installations like distribution boards.
 - *2: Pollution Degree
Describes the degree to which a solid, liquid, or gas which deteriorates dielectric strength or surface resistivity is adhering. "2" applies to normal indoor atmosphere. Normally, only non-conductive pollution occurs.
 - *3: Measurement Category II
Applies to measuring circuits connected to low voltage installation, and electrical instruments supplied with power from fixed equipment such as electric switchboards.

Normal Operating Conditions

- Power voltage:
 - 90 to 132 or 180 to 250 VAC
- Power supply frequency:
 - 50 Hz $\pm 2\%$, 60 Hz $\pm 2\%$
- Ambient temperature:
 - 0 to 50 °C
- Ambient humidity:
 - 20% to 80% RH (at 5 to 40 °C)
- Vibration: 10 to 60 Hz, 0.2 m/s² or less
- Shock: Not acceptable
- Magnetic field:
 - 400 AT/m or less (DC and 50/60 Hz)
- Noise:
 - Normal mode (50/60 Hz):
 - DCV: The peak value including the signal must be less than 1.2 times the measuring range.
 - TC: The peak value including the signal must be less than 1.2 times the measuring thermal electromotive force.
 - RTD: 50 mV or less
 - Common mode noise voltage (50/60 Hz):
 - 250 Vrms AC or less for all ranges
 - Maximum noise voltage between channels (50/60 Hz):
 - 250 Vrms AC or less
- Mounting position:
 - Can be inclined up to 30 deg backward.
 - Mounting at an angle away from the perpendicular is not acceptable.
- Warm-up time:
 - At least 30 min after power on
- Installation location:
 - In-room
- Altitude: Less than 2000 m

Standard Performance

- Measuring and Recording Accuracy:
 - The following specifications apply to operation of the recorder under standard operation conditions.
 - Temperature:
 - 23 \pm 2 °C
 - Humidity:
 - 55% \pm 10% RH
 - Power supply voltage:
 - 90 to 132 or 180 to 250 VAC
 - Power supply frequency:
 - 50/60 Hz \pm 1%
 - Warm-up time:
 - At least 30 min.
- Other ambient conditions such as vibration should not adversely affect recorder operation.

Input	Range	Measurement accuracy (digital display)		Max. resolution of digital display
		A/D integration time: 16.7ms or more	A/D integration time: 1.67ms (fast sampling mode)	
DCV	20 mV	±(0.05% of rdg + 12 digits)	±(0.1% of rdg + 40 digits)	1 µV
	60 mV			10 µV
	200 mV	±(0.05% of rdg + 3 digits)	±(0.1% of rdg + 15 digits)	10 µV
	2 V	±(0.05% of rdg + 12 digits)	±(0.1% of rdg + 40 digits)	100 µV
	6 V			1 mV
	1-5 V	±(0.05% of rdg + 3 digits)	±(0.1% of rdg + 15 digits)	1 mV
	20 V			1 mV
	50 V			10 mV
TC (Excluding RJC accuracy)	R	±(0.15% of rdg + 1°C) However, R, S:	±(0.2% of rdg + 4°C) However, R, S:	0.1°C
	S	±3.7°C at 0 to 100°C ±1.5°C at 100 to 300°C B:	±10°C at 0 to 100°C ±5°C at 100 to 300°C B:	
	B	±2°C at 400 to 600°C Accuracy at less than 400°C is not guaranteed.	±7°C at 400 to 600°C Accuracy at less than 400°C is not guaranteed.	
	K	±(0.15% of rdg + 0.7°C) However, ±(0.15% of rdg + 1°C) at -200 to -100°C	±(0.2% of rdg + 3.5°C) However, ±(0.15% of rdg + 6°C) at -200 to -100°C	
	E			
	J	±(0.15% of rdg + 0.5°C) However,	±(0.2% of rdg + 2.5°C) However,	
	T	±(0.15% of rdg + 0.7°C) at -200 to -100°C	±(0.2% of rdg + 5°C) at -200 to -100°C	
	L			
	U			
	N	±(0.15% of rdg + 0.7°C) However, ±(0.35% of rdg + 0.7°C) at -200 to 0°C Accuracy at less than -200°C is not guaranteed.	±(0.3% of rdg + 3.5°C) However, ±(0.7% of rdg + 3.5°C) at -200 to 0°C Accuracy at less than -200°C is not guaranteed.	
W	±(0.15% of rdg + 1°C)	±(0.3% of rdg + 7°C)		
WRe	±(0.2% of rdg + 2.5°C) However, ±4°C at 0 to 200°C	±(0.3% of rdg + 10°C) However, ±18°C at 0 to 200°C		
RTD	Pt100			
	JPt100	±(0.15% of rdg + 0.3°C)	±(0.3% of rdg + 1.5°C)	

Measurement accuracy in case of scaling (digits):
= measurement accuracy (digits) x scaling span (digits)/measurement span (digits) + 2 digits
Decimals are rounded off to the next highest number.

Reference junction compensation:
INT (internal)/EXT (external) selectable
(common for all channels)

Reference junction compensation accuracy:
Types R, S, B, W, WRe: ± 1 °C
Types K, J, E, T, N, L, U: ± 0.5 °C
(Above 0 °C, input terminal temperature is balanced)

Maximum allowable input voltage:
± 60 VDC (continuous) for all input ranges

Input resistance:
Approx. 10 MΩ or more for DCV ranges of 200 mVDC or less and TC
Approx. 1 MΩ for more than 2 VDC ranges

Input source resistance:
DCV, TC: 2 kΩ or less
RTD: 10 Ω or less per wire (The resistance of all three wires must be equal.)

Input bias current:
10 nA or less (approx. 100nA for TC range with burnout function)

Maximum common mode noise voltage:
250 Vrms AC (50/60 Hz)

Maximum noise voltage between channels:
250 Vrms AC (50/60 Hz)

Interference between channels:
120 dB (when the input source resistance is 500 Ω and the inputs to other channels are 60 V)

Common mode rejection ratio:
A/D integration time 20 ms:
More than 120 dB (50 Hz ± 0.1%, 500 Ω imbalance between the minus terminal and ground)

A/D integration time 16.7 ms:
More than 120 dB (60 Hz ± 0.1%, 500 Ω imbalance between the minus terminal and ground)

A/D integration time 1.67 ms:
More than 80 dB (50/60 Hz ± 0.1%, 500 Ω imbalance between the minus terminal and ground)

Normal mode rejection ratio:
A/D integration time 20 ms:
More than 40 dB (50 Hz ± 0.1%)

A/D integration time 16.7 ms:
More than 40 dB (60 Hz ± 0.1%)

A/D integration time 1.67 ms:
50/60Hz is not rejected.

Effects of Operating Conditions

Ambient temperature: (Only for 16.7 ms A/D integration time or more)

With temperature variation of 10 °C

DCV, TC: $\pm (0.1\% \text{ of rdg} + 0.05\% \text{ of range})$ or less

Excluding the error of reference junction compensation

RTD: $\pm (0.1\% \text{ of rdg} + 2 \text{ digits})$ or less

Power supply:

With variation within 90 to 132 V and 180 to 250 VAC (50/60 Hz):

Within measurement accuracy

With variation of ± 2 Hz from rated power frequency (at 100 VAC):

Within measurement accuracy

Magnetic field:

AC (50/60 Hz) and DC 400 A/m fields:

$\pm (0.1\% \text{ of rdg} + 10 \text{ digits})$ or less

Input source resistance:

(1) DCV range (with variation of +1 k Ω)

200 mVDC range or less:

$\pm 10 \mu\text{V}$ or less

2 VDC range or greater:

$\pm 0.15\% \text{ of rdg}$ or less

(2) TC range (with variation of +1 k Ω)

$\pm 10 \mu\text{V}$

(3) RTD range (Pt100)

With variation of 10 Ω per wire (resistance of all three wires must be equal):

$\pm (0.1\% \text{ of rdg} + 1 \text{ digit})$ or less

With maximum difference of 40 m Ω between wires:

approx. ± 0.1 °C

Transport and Storage Conditions

The following specifies the environmental conditions required during transportation from shipment to the start of service and during storage as well as during transportation and storage if this instrument is temporarily taken out of service.

No malfunction will occur under these conditions without serious damage, which is absolutely impossible to repair; however, calibration may be necessary to recover normal operation performance.

Ambient temperature:

-25 °C to 60 °C

Humidity: 5% to 95% RH (No condensation is allowed.)

Vibration: 10 to 60 Hz, 4.9 m/s² maximum

Shock: 392 m/s² maximum (while being packed)

SPECIFICATIONS OF OPTIONAL FUNCTIONS

Alarm Output Relays (/A1, /A2, /A3, /A4, /A5)

An alarm signal is output from the rear panel as a relay contact signal.

Number or output:

Select from 2, 4, 6, 12 and 24 points

Relay contact rating:

250 VDC/0.1 A (for resistance load), 250

VAC (50/60 Hz)/3 A

Terminal configuration:

SPDT (NO-C-NC). Energized-at-alarm/deenergized-at-alarm,

AND/OR, and hold/non-hold actions are selectable.

Serial Communication Interface (/C2, /C3)

Connection:

EIA RS-232 (/C2) or RS-422A/485 (/C3)

Protocols: DX private protocol, Modbus(master/slave) protocol, DX private bar code protocol (only for /AS 1 option)

Synchronization method:

Start-stop asynchronous transmission

Connection method (RS-422A/485):

4-wire half-duplex multi-drop connection

(1 : N, N = 1 to 31)

Transmission speed:

1200, 2400, 4800, 9600, 19200 or 38400 bps

Data length:

7 or 8 bits

Stop bit: 1 bit

Parity: Odd, even, or none

Communication distance (RS-422A/485):

Up to 1.2 km

Communication mode:

ASCII for input/output for control and setting

ASCII or binary for output of measured data

Setting/measurement server function:

Operation, setting or output of measurement data are available by DX private protocol.

Modbus communication:

Reading or writing of measurement data on other instruments are available by Modbus protocol.

Mathematical function option or external input option is needed to read measurement data from other instruments.

Control operation such as message or batch name writing is available (Modbus slave function).

Operation mode:

RTU MASTER or RTU SLAVE

Modbus master command number:

1 to 16

VGA Video Output (/D5)

Resolution: 640 x 480 pixels (VGA)

Connector: 15 pins D-SUB (DB15HD)

Fail/Status Output (/F1)

The relay contact output on the rear panel indicates the occurrence of CPU failure or selected status.

You can select the contents output to the two relay output signals.

FAIL output relay:

The relay contact output on the rear panel indicates the occurrence of CPU failure.

Relay operation: CPU normal: Energized, CPU failure: Deenergized

Status output relay:

The relay contact output on the rear panel indicates the occurrence of selected status

Relay operation: Status detection:

Energized

Status	Description
Memory status	Relay is energized when internal memory or external storage media is in the following conditions: Abnormality in the internal memory When automatic saving of settings to the external storage media is ON <ul style="list-style-type: none"> • When the remaining space on the external storage medium reaches 10%. • When an abnormality occurs with the external storage medium, and auto save fails • When the external storage medium is not inserted, operation is same as when automatic saving of settings to the external storage media is Off When automatic saving of settings to the external storage media is Off <ul style="list-style-type: none"> • When the remaining space on the internal memory reaches 10% • When the number of data file which is not saved to external storage media exceeds 390 *Not including USB memory connected to the instrument.
Measurement Failure	Relay energized upon A/D converter abnormality or burnout detection
Comm. failure	Relay energized when communication error occurs in the Modbus master
Memory stop	Relay energized upon memory stop
Alarm	Relay energized upon any alarm occurs

- Memory start and stop output
 - Outputting the user locked condition
 - Outputting the presence of login users
- These three are only available with the /AS1 option.

Relay contact rating:
250 VDC/0.1 A (for resistance load), 250 VAC (50/60 Hz)/3A

Fail & Alarm Output Relays 22 points (/F2)

Combination of "Fail/Memory end output function" and "Alarm output relays 22 points".

Clamped Input Terminal (/H2)

Clamped input terminal (detachable type) is used for input terminal.

Available wire size:
0.08 to 1.5 mm² (AWG28 to 16)

Desk Top Type (/H5 [], /H5*)

Provides carrying handle and power cord.
* In case that /P1 is specified together, /H5 must be specified. Power terminal will be screw type and power code will not be provided.

Mathematical Functions (/M1)

Used for calculating data, displaying trends and digital values, and recording calculated data assigned to channels.

Channel assignable to calculated data:
DX2004T, DX2008T:
Up to 12 channels (101 to 112)
DX2010T, DX2020T, DX2030T, DX2040T, DX2048T:
Up to 60 channels (101 to 160)

Max. character length of expression:
120 characters

Operation:
General arithmetic operations:
Four arithmetic operations, square root, absolute, common logarithm, natural logarithm, exponential, power, relational operations (>, ≥, <, ≤, =, ≠), logic operations (AND, OR, NOT, XOR)

Statistical operations:

TLOG (Average, maximum, minimum, summation and P-P value of time series data)
CLOG (Average, maximum, minimum, summation and P-P value of channel series data)

Special operations:

PRE (Previous data)
HOLD(a):b (Hold data of "b" in case of "a" is not "0")
RESET(a):b (Reset data of "b" and restart in case of "a" is not "0")
CARRY(a):b (If "b" exceeds "a", "b-a" becomes computation results)

Conditional operation:

[a?b:c] (Execute "b" in case of "a" is not "0", or execute "c" in case of "a" is "0")

Constant: Up to 60 constants (K01 to K60)

Digital data input via communication:
Up to 60 data (C01 to C60)

External input:

Up to 240 data (201 to 440) (only for external input option)

Remote status input:

Remote input status (0/1) can be used in mathematical expression

Up to 8 inputs (D01 to D08)

Pulse input: Up to 8 pulse count input (P01 to P08, Q01 to Q08) (only for pulse input option)

Status input:

Internal switch status (S01 to S30), relay status (I01 to I36), memory sampling status (M01 to M12) and flag status (F01 to F08) can be used in mathematical expression

Report functions:

Number of report channels:
DX2004T, DX2008T: up to 12 channels
DX2010T, DX2020T, DX2030T, DX2040T:
up to 60 channels

Report type:

Hourly, daily, hourly + daily, daily +weekly and daily + monthly

Operation:

Max. 4 types are selectable from average, maximum, minimum, instantaneous and summation

Data format:

TEXT

Excel spread sheet template function:

reports can be automatically created in XML spread sheet format according to a predefined spread sheet template

Long term rolling average:

Computation interval:
1, 2, 3, 4, 5, 6, 10, 12, 15, 20, 30 sec., 1, 2, 3, 4, 5, 6, 10, 12, 15, 20, 30, 60 min

Number of sampling:

1 to 1500

Cu10, Cu25 RTD Input /3 leg isolated RTD Input (/N1)

This option allows Cu10 and Cu25 inputs to be added to the standard input types.

A, B, b legs are of isolated input type for DX2010T, DX2020T, DX2030T, DX2040T and DX2048T.

Input type Measuring range:

The following specifications apply to operation of the recorder under standard operation conditions.

Temperature:
23 ± 2 °C

Humidity:
55% ± 10% RH

Power supply voltage:
90 to 132 or 180 to 250 VAC

Power supply frequency:
50/60 Hz ± 1%

Warm-up time:
At least 30 min.

Other ambient conditions such as vibration should not adversely affect recorder operation.

Input	Type	Measurement range	Accuracy guaranteed range	Measurement accuracy		Max. resolution of digital display
				A/D integration time: 16.7 ms or more	A/D integration time: 1.67ms (Fast sampling mode)	
RTD *1	Cu10 (GE)	-200 to 300°C	-70 to 170°C	±(0.4% of rdg + 1.0°C)	±(0.8% of rdg + 5.0°C) RTD	0.1°C
	Cu10 (L&N)		-75 to 150°C			
	Cu10 (WEED)		-200 to 260°C			
	Cu10 (BAILEY)		-200 to 300°C			
	Cu10:α =0.00392 at 20°C					
	Cu25:α =0.00425 at 0°C			±(0.3% of rdg + 0.8°C)	±(0.5% of rdg + 2.0°C)	

*1 Measuring current: i = 1mA

Input source resistance:
1 Ω or less per wire (The resistance of all three wires must be equal.)

Ambient temperature: (Only for 16.7 ms A/D integration time or more)
With temperature variation of 10 °C
± (0.2% of rdg + 2 digits) or less

Input source resistance:
With variation of 1 Ω per wire (resistance of all three wires must be equal):
± (0.1% of rdg + 1 digit) or less

With maximum difference of 40 mΩ between wires:
approx. ± 1 °C

3 legs Isolated RTD Input (/N2)

A, B, b legs are of isolated input type.
* Can be specified only for DX2010T, DX2020T, DX2030T, DX2040T and DX2048T.
A, B, b legs of DX2004T and DX2008T are isolated as standard.

Extended Input Types (/N3)

This option allows extra inputs types to be added to the standard input types.

Input type Measuring range:
The following specifications apply to operation of the recorder under standard operation conditions.

Temperature:
23 ± 2 °C

Humidity: 55% ± 10% RH

Power supply voltage:
90 to 132 or 180 to 250 VAC

Power supply frequency:
50/60 Hz ± 1%

Warm-up time:
At least 30 min.

Other ambient conditions such as vibration should not adversely affect recorder operation.

Input	Type	Measurement range	Measurement accuracy		Max. resolution of digital display
			A/D integration time: 16.7 ms or more	A/D integration time: 1.67ms (Fast sampling mode)	
TC	Kp vs Au7Fe	0.0 to 300.0K	Within ±4.5K at 0 to 20K Within ±2.5K at 20 to 300K	Within ±13.5K at 0 to 20K Within ±7.5K at 20 to 300K	0.1 K
	PLATINEL	0.0 to 1400.0°C	±(0.25% of rdg+2.3°C)	±(0.25% of rdg+8.0°C)	0.1°C
	PR40-20	0.0 to 1900.0°C	Accuracy is not guaranteed at 0 to 450°C ±(0.9% of rdg+3.2°C) at 450 to 750°C ±(0.9% of rdg+1.3°C) at 750 to 1100°C ±(0.9% of rdg+0.4°C) at 1100 to 1900°C	Accuracy is not guaranteed at 0 to 450°C ±(0.9% of rdg+15.0°C) at 450 to 750°C ±(0.9% of rdg+6.0°C) at 750 to 1100°C ±(0.9% of rdg+3.0°C) at 1100 to 1900°C	
	NiNiMo	0.0 to 1310.0°C	±(0.25% of rdg+0.7°C)	±(0.5% of rdg+3.5°C)	
	W/WRe	0.0 to 2400.0°C	±15.0°C at 0 to 400°C ±(0.2% of rdg+2.0°C) at 400 to 2400°C	±30.0°C at 0 to 400°C ±(0.4% of rdg+4.0°C) at 400 to 2400°C	
	TypeN(AWG14)	0.0 to 1300.0°C	±(0.2% of rdg+1.3°C)	±(0.5% of rdg+7.0°C)	
	XK GOST	-200.0 to 600.0°C	±(0.25% of rdg +0.8°C) ±(0.25% of rdg +1.0°C) at -200 to -100°C	±(0.5% of rdg +4.0°C) ±(0.5% of rdg +5.0°C) at -200 to -100°C	
RTD *1	Pt50	-200.0 to 550.0°C	±(0.3% of rdg+0.6°C)	±(0.6% of rdg+3.0°C)	0.1 K
	Ni100(SAMA)	-200.0 to 250.0°C	±(0.15% of rdg+0.4°C)	±(0.3% of rdg+2.0°C)	
	Ni100(DIN)	-60.0 to 180.0°C	±(0.15% of rdg+0.4°C)	±(0.3% of rdg+2.0°C)	
	Ni120	-70.0 to 200.0°C	±(0.15% of rdg+0.4°C)	±(0.3% of rdg+2.0°C)	
	J263*B	0.0 to 300.0 K	Within ±3.0K at 0 to 40K Within ±1.0K at 40 to 300K	Within ±9.0K at 0 to 40K Within ±3.0K at 40 to 300K	0.1°C
	Cu53	-200.0~550.0°C	±(0.3% of rdg +0.8°C)	±(0.3% of rdg+4.0°C)	
	Cu100	-50.0 to 150.0°C	±(0.2% of rdg+1.0°C)	±(0.4% of rdg+5.0°C)	
	Pt25	-200.0 to 550.0°C	±(0.15% of rdg +0.6°C)	±(0.3% of rdg +3.0°C)	
	Pt46 GOST	-200.0 to 550.0°C	±(0.3% of rdg +0.8°C)	±(0.6% of rdg +4.0°C)	
	Pt100 GOST	-200.0 to 600.0°C	±(0.15% of rdg +0.3°C)	±(0.3% of rdg +1.5°C)	
	Cu10 GOST	-200.0 to 200.0°C	±(1.5% of rdg+3.0°C)	±(3.0% of rdg +15.0°C)	
	Cu50 GOST	-200.0 to 200.0°C	±(0.4% of rdg +0.5°C)	±(0.8% of rdg +2.5°C)	
	Cu100 GOST	-200.0 to 200.0°C	±(0.15% of rdg +0.3°C)	±(0.3% of rdg +1.5°C)	
Pt200(WEED)	-100.0 to 450.0°C	±(0.3% of rdg +0.6°C)	±(0.6% of rdg +3.0°C)		

*1 Measuring current: i = 1mA

Input source resistance:

- TC: 2 kΩ or less
- RTD: 1 Ω or less per wire (The resistance of all three wires must be equal.)

Ambient temperature: (Only for 16.7 ms A/D integration time or more)

- With temperature variation of 10 °C
- TC: ± (0.1% of rdg + 0.05% of range) or less Excluding the error of reference junction compensation.
- RTD: ± (0.2% of rdg + 2 digits) or less

Input source resistance:

- (1) TC range (with variation of + 1 kΩ)
±10 μV
- (2) RTD range
With variation of 1 Ω per wire (resistance of all three wires must be equal):
± (0.1% of rdg + 1 digit) or less
With maximum difference of 100 mΩ between wires:
approx. ± 1 °C

24 VDC/AC Power Supply (/P1)

- Rated power supply: 24 VDC or 24 VAC (50/60Hz)
- Allowable power supply voltage range:
21.6 to 26.4 VDC/AC
- Insulation resistance:
Power supply to ground terminal: 20 MΩ or greater (at 500 VDC)
- Dielectric strength:
Power supply to ground terminal: 500 VAC (50/60 Hz), 1 min

Max. power consumption:

Supply voltage	LCD off	Normal	Max.
24 VDC	12 VA	20 VA	45 VA
24 VAC (50/60 Hz)	20 VA	34 VA	70 VA

Remote Control (/R1)

This option allows eight functions to be controlled remotely by a contact input. Please refer the part of "Event action function" for functions to be controlled.

24 VDC transmitter power supply (/TPS4, /TPS8)

- Output voltage:
22.8 to 25.2 VDC (rated load current)
- Rated output current:
4 to 20 mADC
- Max. output current:
25 mADC (current to guard operation against overcurrent: approx. 68 mADC)
- Allowable conductor resistance:
RL ≤ (17.8 - transmitter minimum operation voltage)/0.02 A (not include drop voltage with load shunt resistance)
- Max. length of wiring:
2 km (CEV cable)
- Insulation resistance:
output terminal to grand terminal more than 20 MΩ (500 VDC)

Dielectric strength:
 Output terminal to grand terminal:
 500 VAC (50/60 Hz, I = 10 mA), 1 min
 Between output terminal:
 500 VAC (50/60 Hz, I = 10 mA), 1 min

USB interface (/USB1)

USB interface specification:
 Based on Rev1.1, host function
 Number of ports:
 2 ports (Front and rear panel)
 Power supply:
 5V, 500mA (for each port)*1
 Available USB devices:
 Keyboard: 104/89 keyboard (US) based on USB HID Class Ver.1.1
 External medium:
 USB flash drive (some of USB flash drives may not be supported by DXAdvanced)
 Barcode reader:
 Interface based on USB HID Class Ver.1.1 and supports standard US keyboard
 *1: For low powered devices (bus power < 100 mA):
 5V ± 5%
 For high powered devices (bus power < 500 mA):
 5V ± 10%
 Devices which need more than 500 mA total bus power for 2 ports can not be connected at the same time.

Pulse input (/PM1)

Pulse input option includes mathematical functions option (/M1) and remote control option (/R1).
 Number of inputs:
 3 points (8 points are available in case of using remote inputs)
 Input format:
 Photocoupler isolation (shared common)
 Isolated power supply for input terminal (approx. 5 V)
 Input type:
 Non-voltage contact:
 Close: 200 Ω or less, Open: 100 kΩ or more
 Open collector:
 ON: 0.5 V or less (30 mADC), Leakage current of OFF: 0.25 mA or less
 Counting: Counts rising edges of pulses
 Allowable input voltage:
 30 VDC
 Max. sampling pulse period:
 Max.100 Hz
 Minimum pulse length:
 5 ms
 Pulse detection period:
 Approx. 3.9 ms (256Hz)
 Pulse measuring accuracy:
 ±1 pulse (for instantaneous mode)
 Pulse count period:
 Counts the number of pulse per measurement period (P01 to P08) or per second (Q01 to Q08).

Calibration correction function (/CC1)

Corrects the measurement value of each channel using segment linearizer approximation.
 Number of segment points:
 2 to 16
 Calibration correction control function:
 You can specify how calibration correction settings are periodically performed

External input function (/MC1)

Digital input channels via communication or Modbus master function are extended to input data from other instruments*.
 Number of external input channels:
 Up to 240 channels (channel number: 201 to 440)
 * Only for DX2010T, DX2020T, DX2030T, DX2040T and DX2048T
 * Fast sampling mode is not available with external input function option.

Multi-batch function (/BT2)

This option allows to start/stop the independent data file for each batch and creating independent data file*.
 * Only for DX2010T, DX2020T, DX2030T, DX2040T and DX2048T.
 * Fast sampling mode is not available when the multi-batch function is being used.

Number of batches:
 2 to 12
 Independent operation for each batch:
 Memory start/stop, math reset, writing message
 Common operation for all batches:
 Math start/stop, report start/stop, manual sample, setting data save/load
 Measurement interval:
 Only normal mode (fast sampling mode is not available), 1 s fastest (common for all batches)
 Data type:
 Display data file or event data file only.
 Trigger mode is not available for event data file.
 Data saving period:
 Common for all batches
 Data file:
 Each display/event data file is created for each batch
 Number of group:
 12 groups maximum for each batch
 10 channels maximum for each group
 Number of timer and match time timer:
 12 timers maximum
 Independent settings for each batch:
 Group setting, trip line setting, file header setting, data file name setting, text field setting, batch number setting, lot number setting

PROFIBUS-DP Communication Interface (/CP1)

PROFIBUS-DP master device can access to internal data below.
 Reading measurement channel data
 Reading mathematical channel data
 Writing communication input channel data (32 channels maximum)
 Note: When the computation function option is installed, PROFIBUS-DP always uses communication input channels C01-C32, therefore it is not possible to read/write to the same communication input using other communication functions.

Data mapping:

Buffer	Description	Max. size
Input	Measurement data are mapped from top of buffer Math channel data are mapped in rest of buffer	128 byte
Output	Communication input channel data are mapped (32 channels max.)	128 byte

Node address setting range:
0 to 125

Interface:

PROFIBUS-DP-V0 Slave

Transmission medium:

2 wires exclusive cable (2 wires for signal)

Transmission speed/distance:

9.6 kbps/1200m to 12Mbps/100m

Terminator:

Not included (external terminator is needed)

Advanced security function (/AS1)

Security and electronic record/signature functions have been added that are compliant with the USA's FDA title 21 CFR Part 11.

Data anti-tamper function:

Settings and measured data are saved as encrypted binary files.

Data type:

Only for display or event
Trigger mode is not possible with event data.

Login function:

Using the login function described below, you can enter security settings on the instrument

- User name
- Password
- User ID (depend on setting)

User level and number of users:

System administrator: 5 users (all can be operated)
General user: 90 users (With user restrictions, you can set restrictions on performing operations and sign authority .)

User restrictions setting: 10 kinds (for general users)

Password expiration time:

select form Off, 1 month, 3 month, 6month

Password control function:

Logins are verified by a Kerberos authentication server* (only user name and password)

Encryption method:

- AES128-CTS-HMAC-SHA1-96
- AES256-CTS-HMAC-SHA1-96
- ARCFOUR-HMAC-MD5

Pre-Auth function: use

* The function has confirmed compatibility with Windows Server2003 SP2/Windows Server2008 SP2 Active Directory

Signature function:

After checking data that has finished being recorded, you can add three levels of electronic signature, select a pass/fail, and enter comments (32 characters maximum)

Audit trail function:

The operation log, the settings change log and the settings file when the change was made are saved.

Individual alarm ACK function:

Alarm display and relay output can be cancelled on individual alarms
ACK can be performed in the overview display

Extended alarm delay time:

Alarm delay times of up to 24 hours can be set

APPLICATION SOFTWARE

DAQSTANDARD

Operating environment

OS: Windows 2000 SP4
Windows XP (Home Edition SP3, Professional SP3)*
* Except for Professional x64 Edition
Windows Vista (Home Premium SP1, SP2, Business SP1, SP2)*
* Except for 64-bits editions
Windows 7 (Home Premium 32-bit and 64-bit editions, Professional 32-bit and 64-bit editions)

Processor and main memory

2000/XP: Intel Pentium III, 600 MHz or faster x64 or x86, 128MB or more
Vista: Intel Pentium 4, 3GHz or faster x64 or x86, 2GB or more
7: 32-bit edition Intel Pentium 4, 3GHz or faster x64 or x86, 2GB or more
64-bit edition Intel x64 processor that is equivalent to Intel Pentium 4, 3 GHz or faster, 2GB or more

Hard disk: 100MB or more of free space

Display: A video card that is recommended for the OS and a display that is supported by the OS, has a resolution of 1024 × 768 or higher, and that can show 65,536 colors (16-bit, high color) or more.

Configuration software:

Setting mode: Configuration of setting mode and basic setting mode
Configuration via communication: Configuration of setting mode and basic setting mode without communication configuration (ex. IP address)

Data viewer software:

Number of display channels: 32 channels per group, 50 groups maximum

Viewer function

Waveform display, digital display, circular display, list display, report display, operation log display etc.

Signature function:

Three levels of electronic signature, select a pass/fail, and comments (32 characters maximum) can be inserted on the currently displayed data file
* Applying electronic signatures to data files created using the password management function requires a network that can connect with the Kerberos authentication server set on the main unit.

Data conversion:
File conversion to ASCII, Lotus 1-2-3 or
MS-Excel format

DAQStudio (optional)

Custom display builder software

Operating environment

OS: Windows XP (Home Edition SP3,
Professional SP3)*
* Except for Professional x64 Edition
Windows Vista (Home Premium SP1,
SP2, Business SP1, SP2)*
* Except for 64-bits editions
Windows 7 (Home Premium 32-bit and
64-bit editions, Professional 32-bit and
64-bit editions)

Processor

XP: Intel Pentium 4, 1.6 GHz or faster x64 or
x86 processor
Vista: Intel Pentium 4, 3GHz or faster x64 or
x86 processor
7: 32-bit edition Intel Pentium 4, 3GHz or
faster x64 or x86 processor
64-bit edition Intel x64 processor that is
equivalent to Intel
Pentium 4, 3 GHz or
faster

Memory: 512 MB or more (Windows XP)
2 GB or more (Windows Vista/7)

Hard disk: 100MB or more of free space

Display: A video card that is recommended for the
OS and a display that is supported by the
OS, has a resolution of 1024 × 68 or
higher, and that can show 65,536 colors
(16-bit, high color) or more.

General functions

- (1) Send and receive the parts layout data of the
custom display (via Ethernet or CF card).
- (2) Display the custom screens, create new custom
display and edit.
- (3) Save and load the file of configured or edited
custom display data.

MODEL AND SUFFIX CODES

Model code	Suffix code	Optional code	Description
DX2004T			4ch, 125ms (Fast sampling mode: 25ms)
DX2008T			8ch, 125ms (Fast sampling mode: 25ms)
DX2010T			10ch, 1s (Fast sampling mode: 125ms)
DX2020T			20ch, 1s (Fast sampling mode: 125ms)
DX2030T			30ch, 1s (Fast sampling mode: 125ms)
DX2040T			40ch, 1s (Fast sampling mode: 125ms)
DX2048T			48ch, 1s (Fast sampling mode: 125ms)
Internal memory	-3		400MB
External media	-4		CF card (with media)
Display language	-2		English/German/French, degF, DST(summer/winter time)
Options		/A1	Alarm output 2 points *1
		/A2	Alarm output 4 points *1 *10
		/A3	Alarm output 6 points *1
		/A4	Alarm output 12 points *1 *9 *10
		/A5	Alarm output 24 points *1 *2 *8 *10
		/C2	RS-232 interface *3
		/C3	RS-422A/485 interface *3
		/D5	VGA output
		/F1	FAIL/Status output *2 *4 *9 *10
		/F2	FAIL + Alarm output 22 points *1 *4 *8 *10
		/H2	Clamped input terminal (detachable)
		/H5	Desktop type (only for /P1 model, without power cable, screw type power terminal) *5
		/H5[]	Desktop type *5 *6
		/M1	Mathematical functions *10
		/N1	Cu10,Cu25 RTD input/3 leg isolated RTD
		/N2	3 leg isolated RTD *7
		/N3	Extended input type (PR40-20, Pt50, etc.)
		/P1	24VDC/AC power supply *5
		/R1	Remote control *10
		/TPS4	24VDC transmitter power supply (4 loops) *8
		/TPS8	24VDC transmitter power supply (8 loops) *8 *9 *10
		/USB1	USB interface
		/PM1	Pulse input (including remote control and mathematical functions) *10
		/CC1	Calibration correction function
		/MC1	External input function *11
		/BT2	Multi-batch function *12
		/CP1	PROFIBUS-DP communication interface *3
		/AS1	Advanced security function

- *1 /A1, /A2, /A3, /A4, /A5, /F2 cannot be specified together.
- *2 /A5 and /F1 cannot be specified together.
- *3 /C2, /C3 and /CP1 cannot be specified together.
- *4 /F1 and /F2 cannot be specified together.
- *5 In case that 24 VDC/AC power supply (/P1) and desktop type are specified together, /H5 must be specified.
/P1 and /H5[] cannot be specified together.
- *6 /H5[]
 - D: Power cord UL, CSA st'd
 - F: Power cord VDE st'd
 - R: Power cord SAA st'd
 - J: Power cord BS st'd
 - H: Power cord GB st'd
- *7 /N2 can be specified for only DX2010T, DX2020T, DX2030T, DX2040T and DX2048T.
- *8 /TPS4, /TPS8, /A5 and /F2 cannot be specified together.
- *9 In case that /TPS8 is specified, combination of /A4/F1 cannot be specified together.
- *10 In case that /PM1 is specified, /A5, /F2, /M1 and /R1 cannot be specified. And combination of /A2/F1 and combination of /A4/TPS8 cannot be specified together.
- *11 /MC1 can be specified for only DX2010T, DX2020T, DX2030T, DX2040T and DX2048T.
- *12 /BT2 can be specified for only DX2010T, DX2020T, DX2030T, DX2040T and DX2048T.
In case that standard memory is specified, maximum number of batches is 6.

Application Software

Model code	Description	O S
DXA120	DAQSTANDARD software	Windows 2000/XP/Vista/7
DXA170	DAQStudio software (optional)	Windows XP/Vista/7
DXA250	DAQManager (optional)	Windows XP/Vista/7

STANDARD ACCESSORIES

Product	Qty
Mounting brackets	2
Terminal screws	5
Door lock key	2
Operation guide	1
User's manual (CD)	1
DAQSTANDARD software (CD)	1
CF card (128MB)	1
Power cable *1	1

*1 For /H5[] option

OPTIONAL ACCESSORIES

Product	Model code (part number)	Specification
Shunt resistor (for screw input terminal)	415920	250 $\Omega \pm 0.1\%$
	415921	100 $\Omega \pm 0.1\%$
	415922	10 $\Omega \pm 0.1\%$
Shunt resistor (for clamped input terminal)	438920	250 $\Omega \pm 0.1\%$
	438921	100 $\Omega \pm 0.1\%$
	438922	10 $\Omega \pm 0.1\%$
CF card adapter	772090	–
CF card	772093	512 MB
	772094	1 GB
	772095	2 GB
Mounting bracket	B9900BX	–
Door lock key	B8706FX	–
Validation document	438230	For /AS1 option (CD)

DIMENSIONS

Dimensions

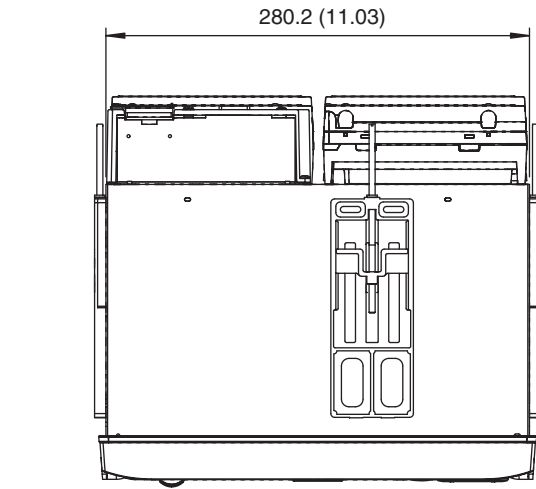

Panel Cutout & Spacing

Unit : mm
(approx.inch)

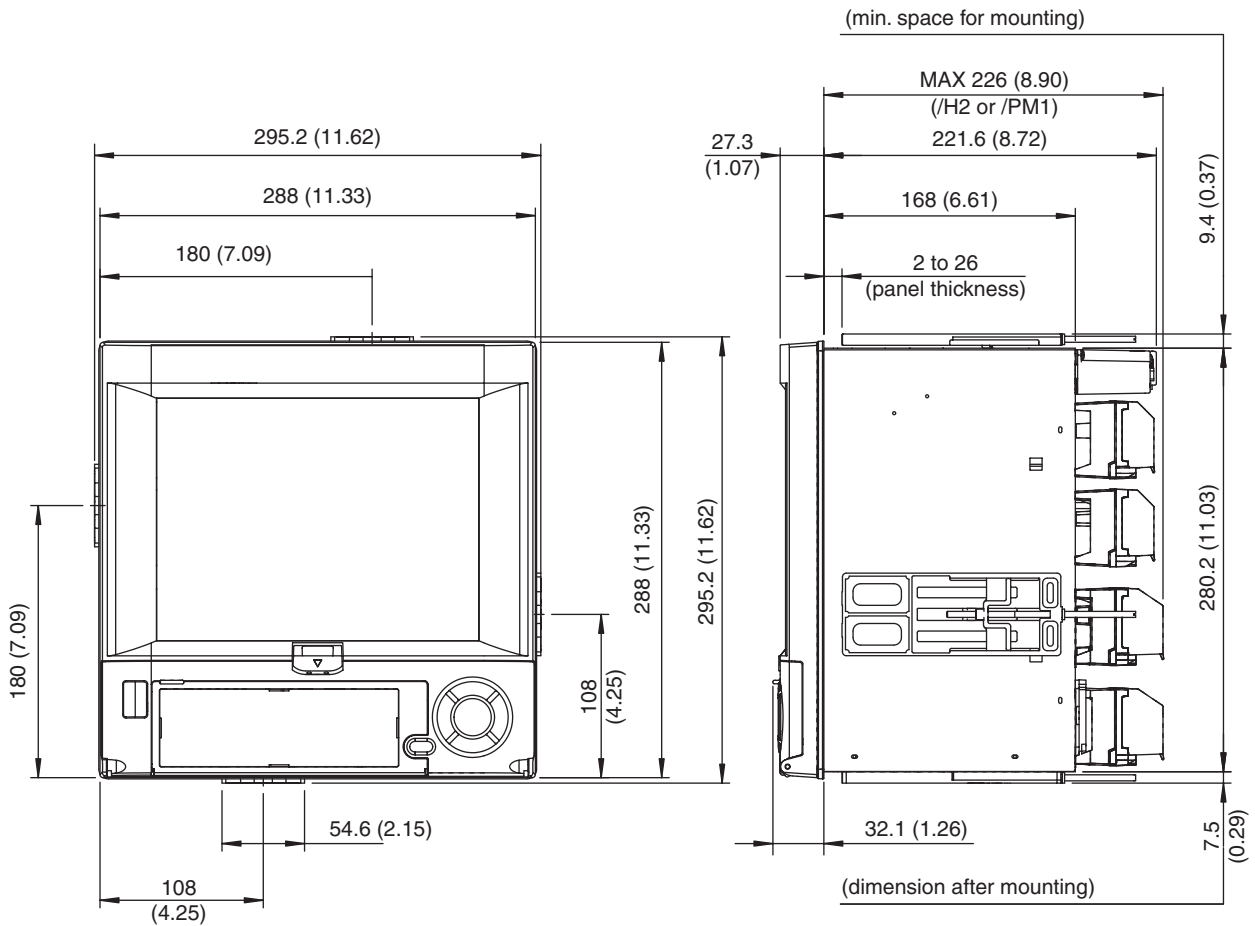
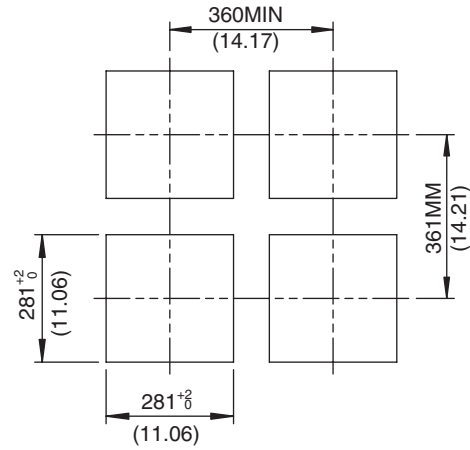

Note: If not specified, the tolerance is $\pm 3\%$. However, for dimensions less than 10mm, the tolerance is $\pm 0.3\text{mm}$.

Desk-top type

Unit : mm
(approx.inch)

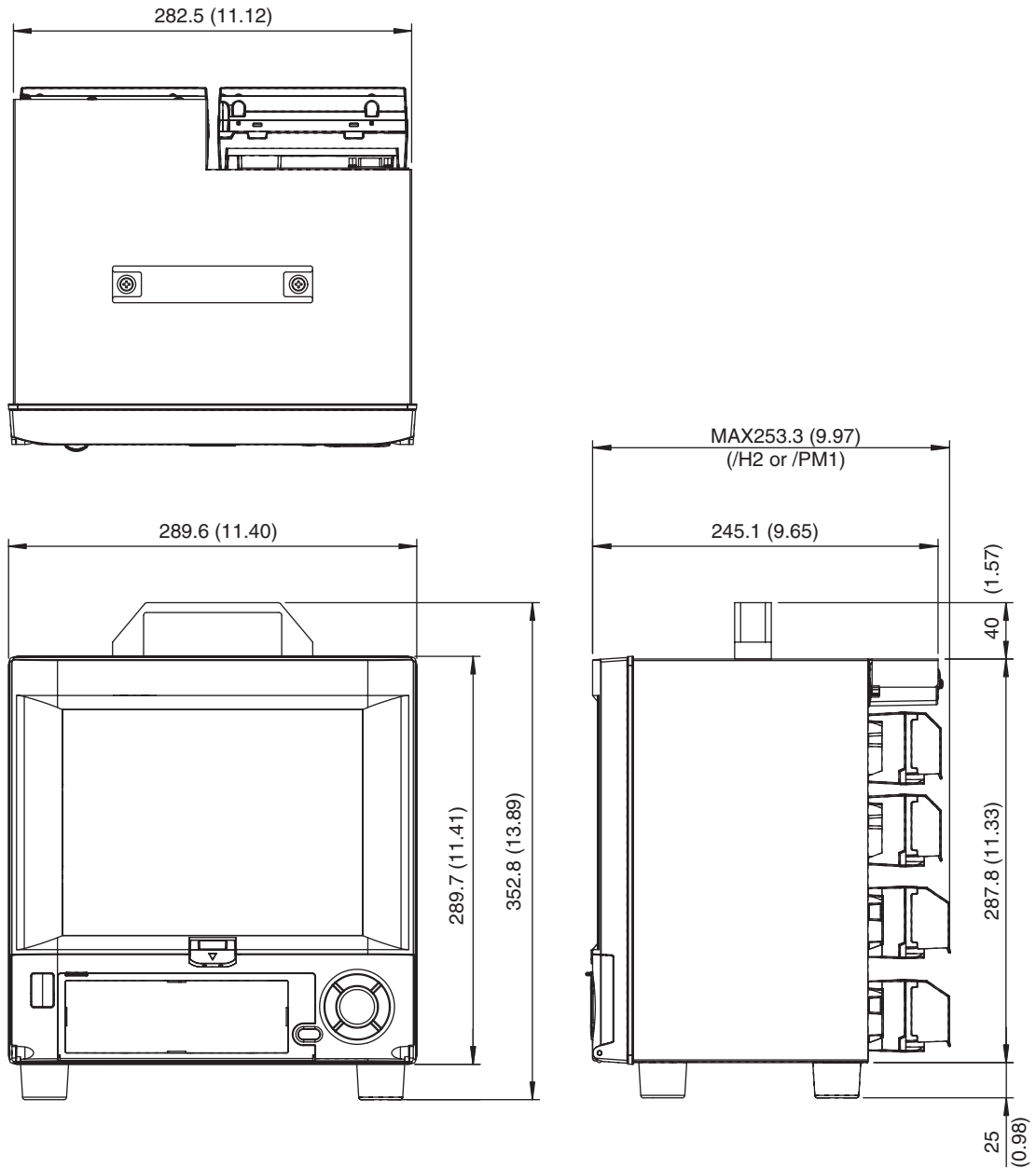

Note: If not specified, the tolerance is $\pm 3\%$. However, for dimensions less than 10mm, the tolerance is $\pm 0.3\text{mm}$.

Rear View

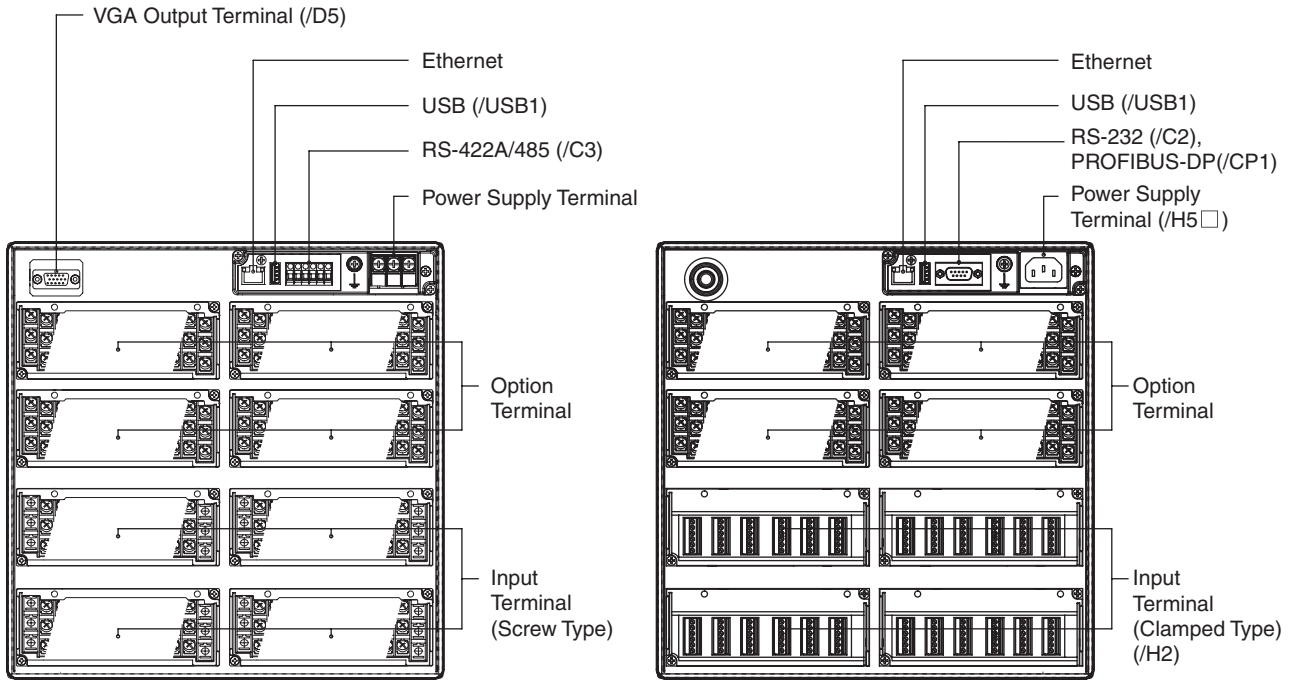

Power Supply Terminal

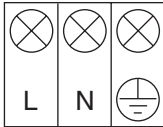

RS-422-A/485 Terminal

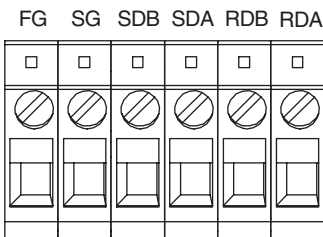

RS-232 Terminal

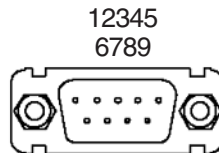

1	N.C.
2	RD
3	SD
4	N.C.
5	SG
6	N.C.
7	RS
8	CS
9	N.C.

Input Terminals

Screw Terminals

DX2004T, DX2008T

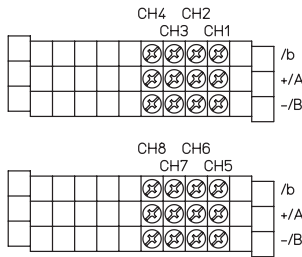

DX2010T, DX2020T, DX2030T, DX2040T

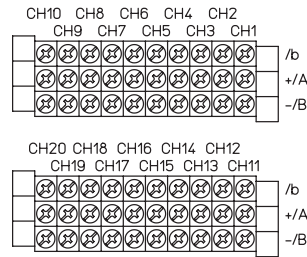

DX2048T

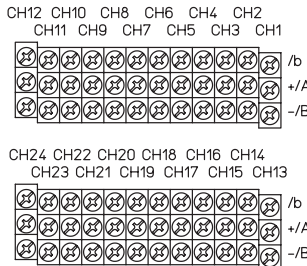
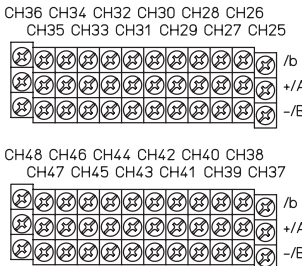

Clamped Terminals (/H2)

DX2004T, DX2008T

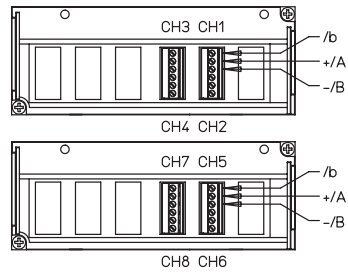

DX2010T, DX2020T, DX2030T, DX2040T

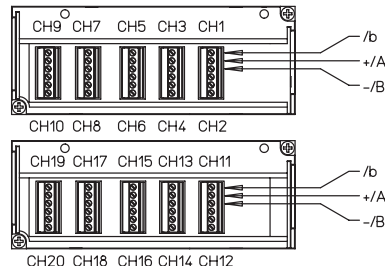

DX2048T

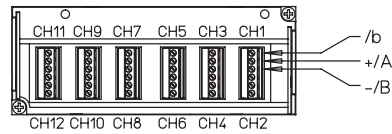

Option Terminals

/A1/F1/PM1 Combination

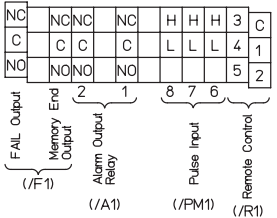

/A2/F1/R1 Combination

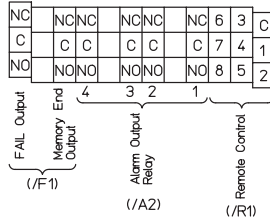

/A3/R1 Combination

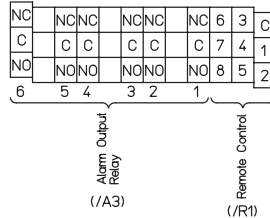

/A4/TPS4 Combination

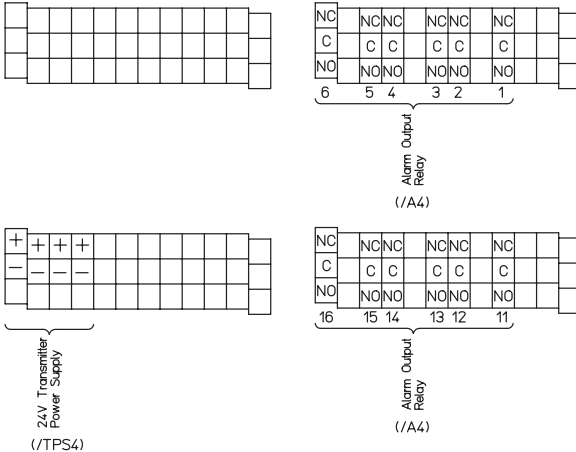

/A5/R1 Combination

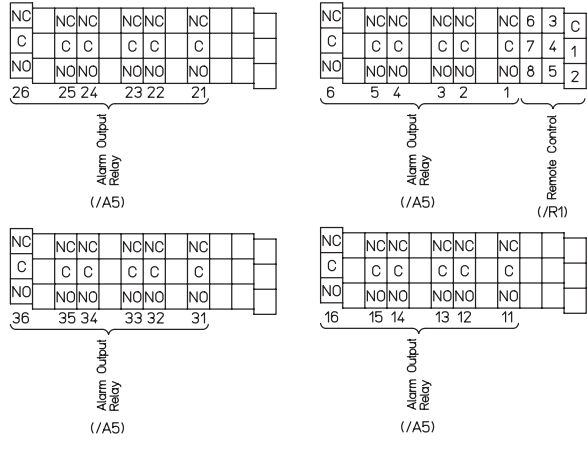

The TCP/IP software used in this product and the document for that TCP/IP software are based in part on BSD networking software, Release 1 licensed from The Regents of the University of California.

- Daqstation, DXAdvanced and DAQstudio are registered trademark of Yokogawa Electric Corporation.
- Microsoft, MS and Windows are registered trademarks of Microsoft Corporation USA.
- Lotus and 1-2-3 are registered trademark of Lotus Development Corporation.
- Pentium are registered trademarks of Intel Corporation.
- Ethernet is a registered trademark of XEROX Corporation.
- Modbus is a registered trademark of AEG Schneider.
- PROFIBUS-DP is a registered trademark of PROFIBUS User Organization.
- EtherNet/IP is a trademark of ODVA (Open DeviceNet Vendor Association).
- Kerberos is a trademark of MIT.
- Other company and/or product names are registered trade mark of their manufactures.